



# INSTALLATION INSTRUCTIONS

## PART NUMBER: RK-3909

This Assembly Fits:

SEE CATALOG FOR CURRENT APPLICATIONS

Congratulations, you have purchased the finest Custom Air Cleaner that money can buy. With proper care, this filter will last 1 million miles or more. This Custom Air Cleaner replaces the stock air cleaner assembly. The following procedure **MUST** be followed to ensure a proper fit and seal of the Custom Air Cleaner.

**\* On Non-US models an Intake Solenoid Actuator Eliminator will need to be purchased separately before the installation of Custom Air Cleaner. \***

### PARTS LIST:

Description	Qty.	Part #
A Air Cleaner Cover Screw	1	Stock Component
B Air Cleaner Cover	1	Stock Component
C Breather Bolts	2	Stock Component
D Air Filter	1	E-3014
E Back Plate, Aluminum	1	01903-1
<b>KRK3901-1:</b>		
F Screw; 1/4-20 x 3/4 Soc. HD., SS	3	07731
G Bolt; 1/4-20 x 1/2 Buttn. Sockets, SS	6	07706
H Breather Bolt Extension	2	82929
I Spacer; .380"OD x 0.80"ID x 1.5"L	3	06411
J H/D Velocity Stack	1	08922-2
K Washer; .750" OD, .379"ID, .040	2	08273
L Bracket	1	070066
M Gasket	1	09267
N Spacer .406"ID X 875"OD X .125"	2	06403
O Grommet	1	08100

### NOT SHOWN

Cable Ties	1	21589
Thread Locker	1	Roush-482

### TOOLS:

# 27 TORX  
 3/16" Allen Wrench  
 5/16" Allen Wrench  
 7/16" Socket  
 3/4" Wrench  
 5/32" Wrench  
 Extension  
 Ratchet

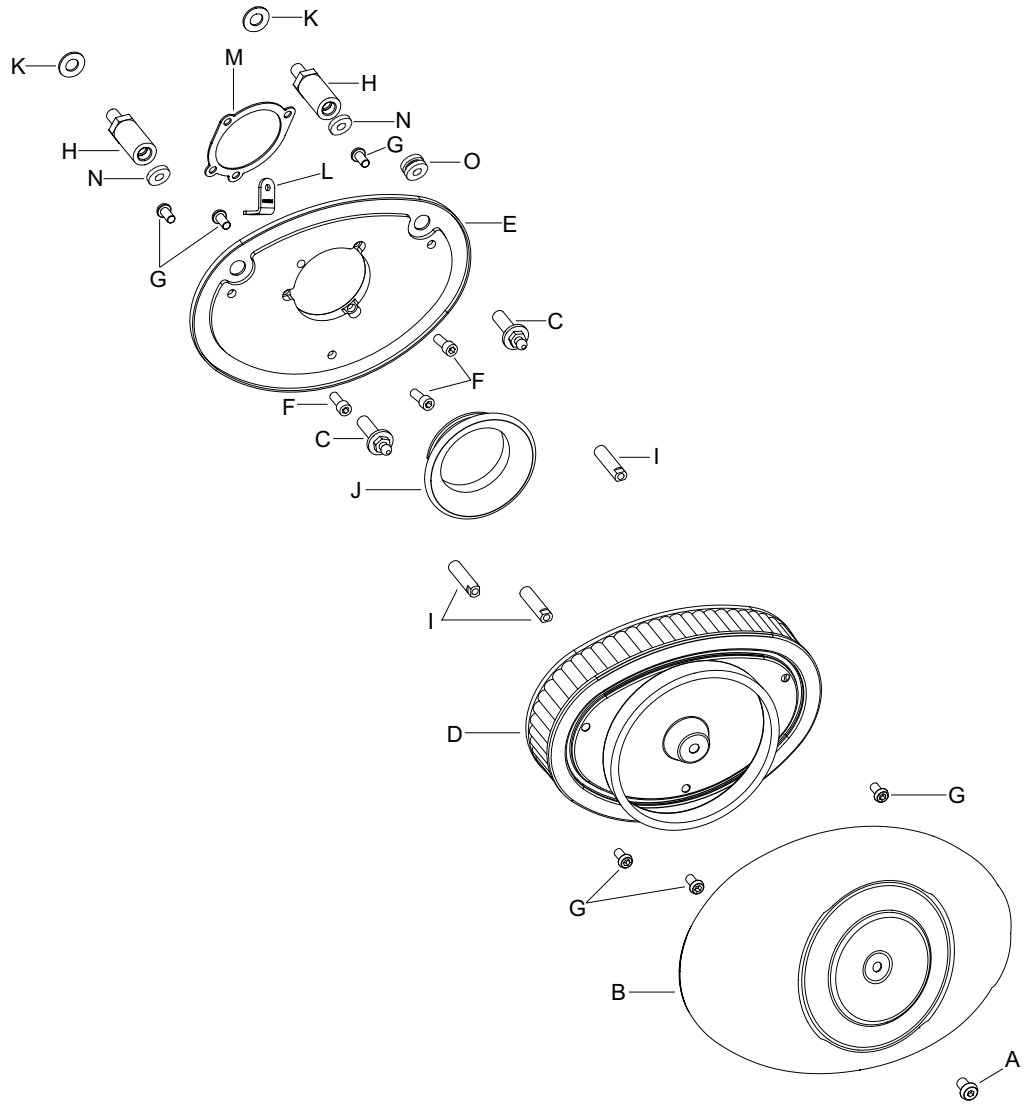

**NOTE: FAILURE TO FOLLOW INSTALLATION INSTRUCTIONS AND NOT USING THE PROVIDED HARDWARE MAY DAMAGE THE THROTTLE BODY AND ENGINE.**

### TO START:

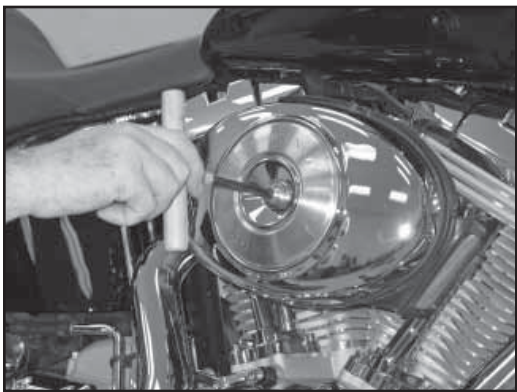

1. Remove the air filter cover mounting bolt and cover from the vehicle as shown.

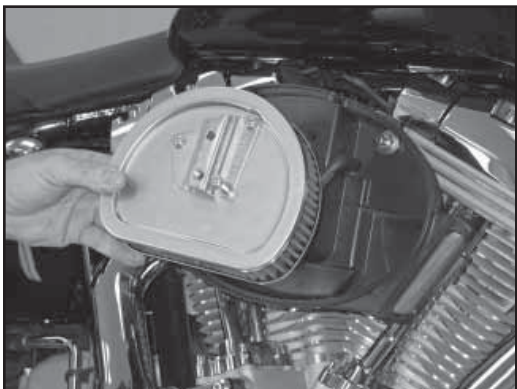

2. Remove the three bolts which secure the stock air filter element. Then remove the stock air filter element and stock crank case breather hoses as shown.

**NOTE: The stock breather hoses will not be reused with the K&N custom assembly.**

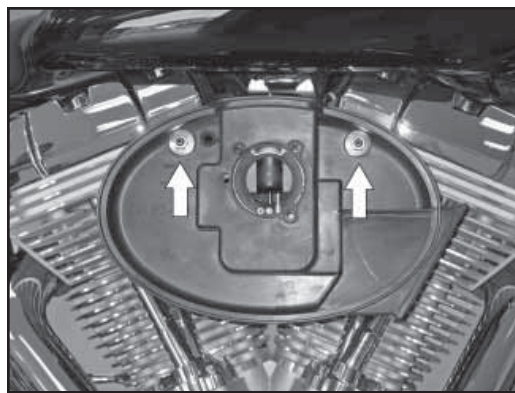

3. Remove the stock breather bolts which secure the stock air filter base shown.

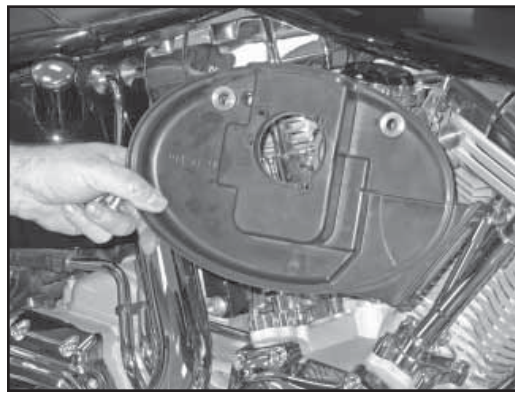

4. Remove the stock air filter base from the engine as shown.

**NOTE: Be sure to remove the stock air filter gasket.**

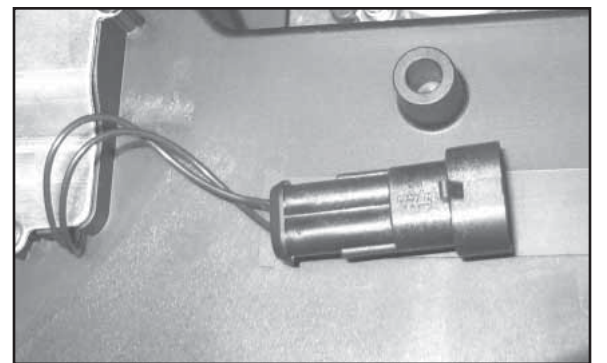

5. Some models are equipped with an intake valve solenoid connector on the back of the stock air filter back plate. Unhook the connector from back plate.

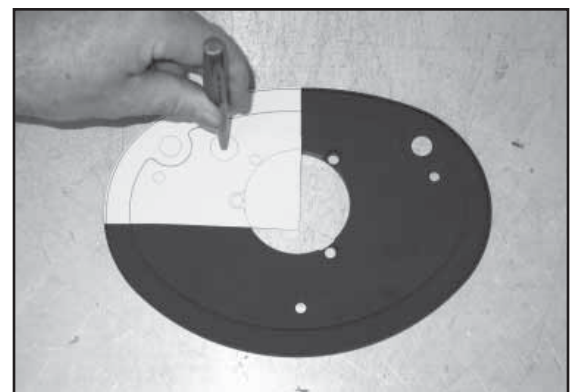

6. Some vehicles are equipped with a carbon canister vent line that connects into the backing plate. Use the provided template to mark the K&N backing plate drilling location as shown.

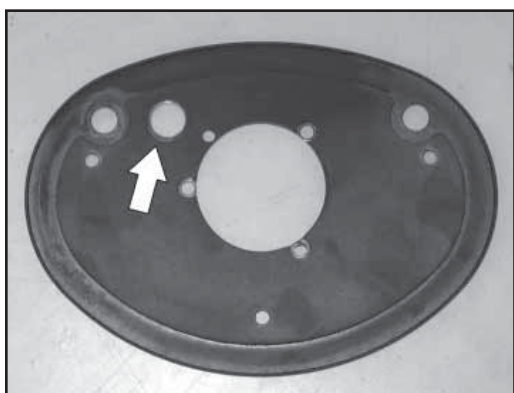

7. On vehicles equipped with a carbon canister, drill a 5/8" ID hole in the backing plate at the marked location from the previous step.

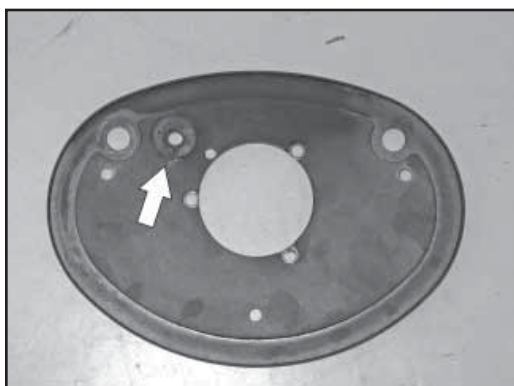

8. On vehicles equipped with a carbon canister, install the provided grommet into the backing plate as shown.



9. Install the provided velocity stack into the K&N backing plate as shown.

**NOTE: Be sure the three mounting holes in the velocity stack align with the mounting holes in the backing plate.**

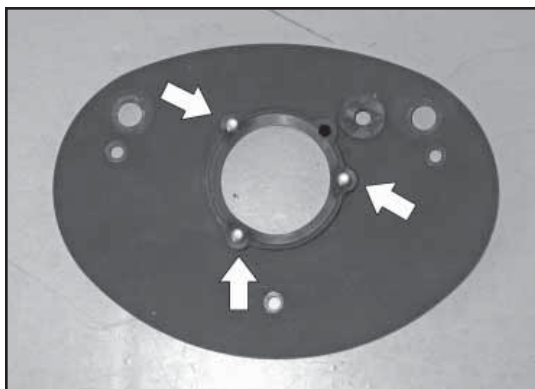

10. Install the three backing plate mounting bolts through the velocity stack as shown. **NOTE: Apply the supplied thread locker to the threads of the three supplied stand-off bolts.**

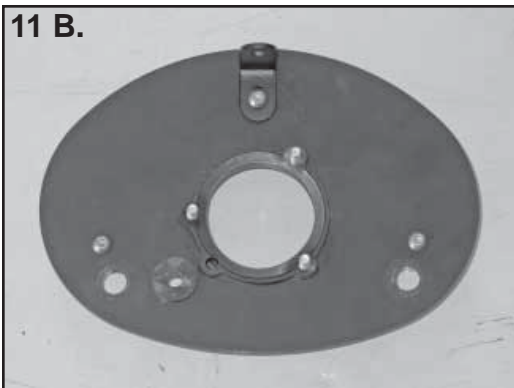
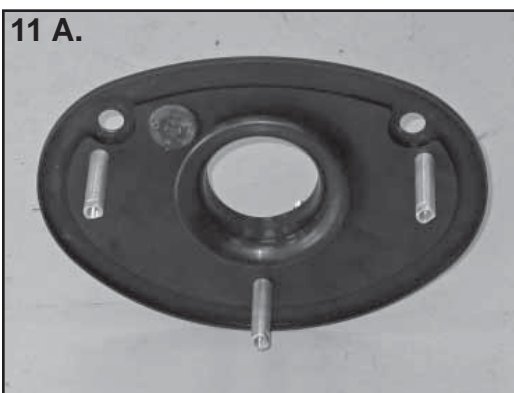

11. Install the three stand-offs onto the backing plate using the three bolts from the previous step.

**NOTE: On models equipped with intake valve solenoid, be sure to install the provided bracket with the bottom stand-off bolt.**

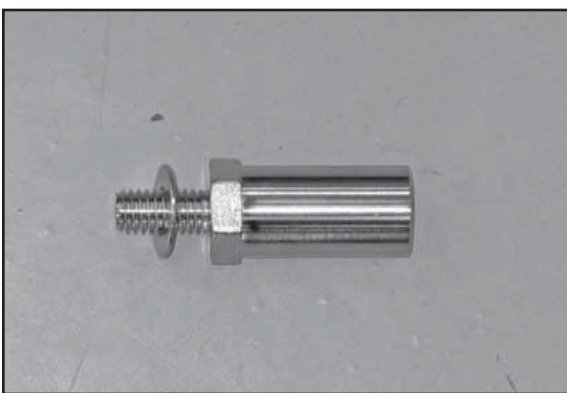

12. Install the provided thin washer on each of the two provided breather extensions as shown.

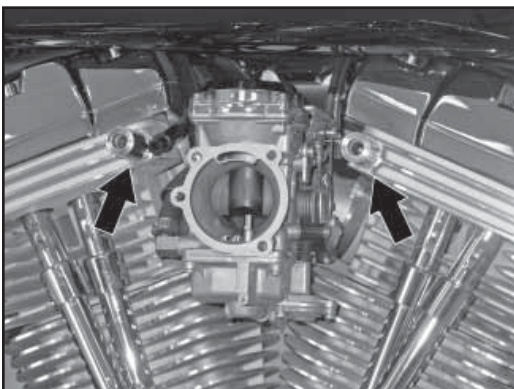

13. Install the breather extensions into the stock breather bolt location as shown.

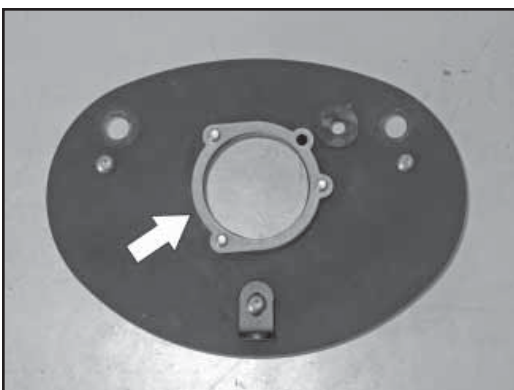

14. Install the provided gasket onto the K&N backing plate as shown.

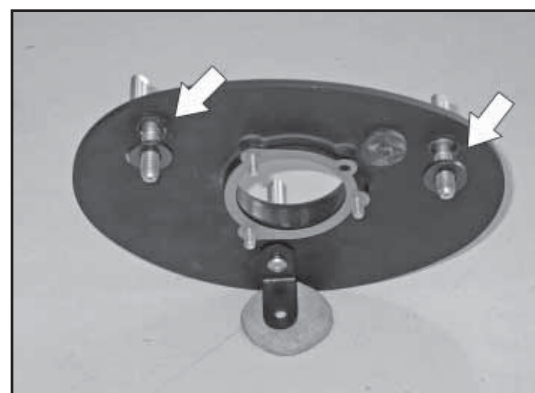

15. Install the factory breather bolts through the K&N back plate. On 2006 and later model year fuel injection models and all carbureted models, install the provided thick spacers (06403) onto the breather bolts as shown.

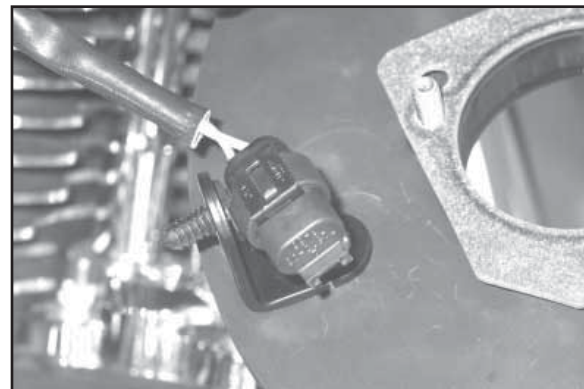

16. On vehicles equipped with an intake valve solenoid, install the intake valve solenoid connector into the bracket installed onto the rear of the backing plate. Secure with the provided tie wrap.

**NOTE: A bypass module will need to be installed (sold separately) on the connector to eliminate an engine management light from turning on (Non-US models only).**

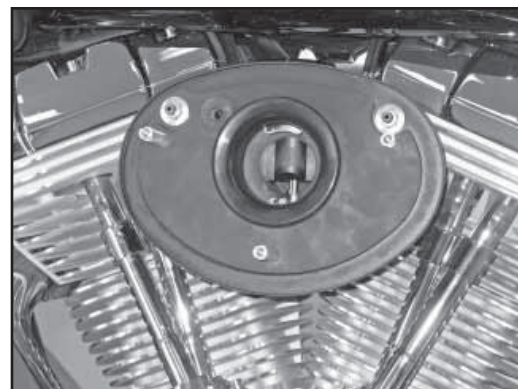

17. Install the back plate and secure with the stock breather bolts.

**NOTE: Do not completely tighten at this time.**

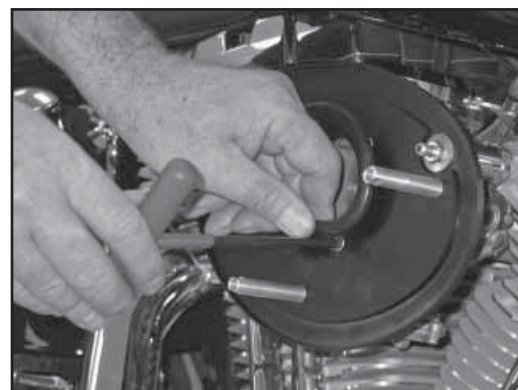

18. Tighten the three bolts that secure the back plate to the throttle body/carburetor. Then tighten the two breather bolts fully.

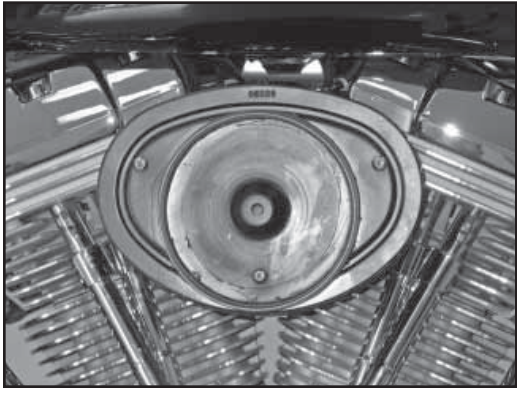

19. Install the K&N air filter and secure with the three bolts provided.

**NOTE: Be sure the filter is properly sealed before completely tightening the mounting bolts.**

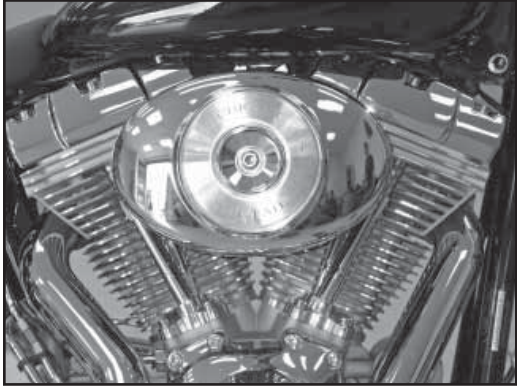

20. Reinstall the factory chrome cover and secure with the factory bolt.

**NOTE: Be sure to not over tighten the mounting bolt and distort the cover.**

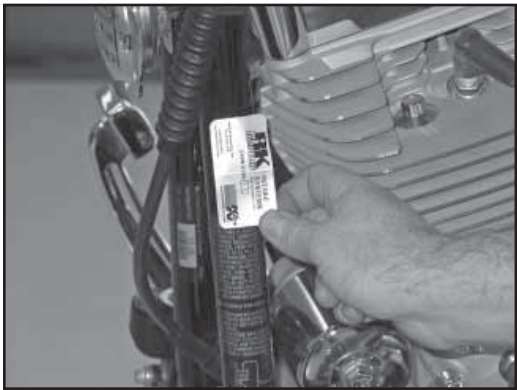

21. Install the E.O. sticker near the vehicle emissions label as shown.

### Drilling Template For Step 6.

